

SILLON DE 2 CUERPOS

VISTA FRONTAL

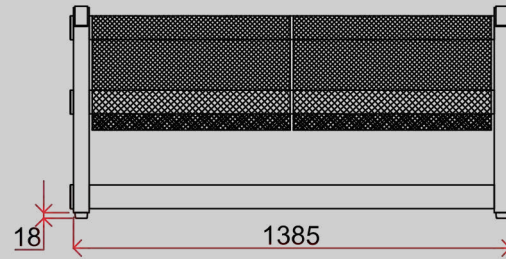

VISTA LATERAL

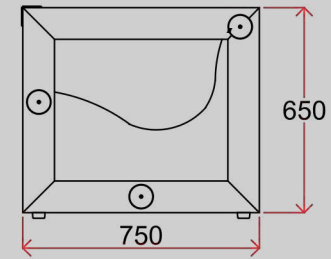

SILLON DE 1 CUERPO

VISTA FRONTAL

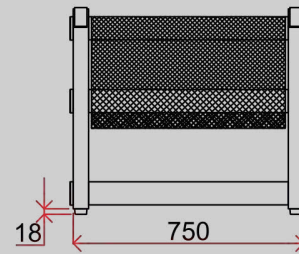

VISTA LATERAL

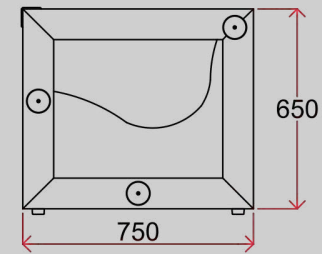

MESA

VISTA FRONTAL

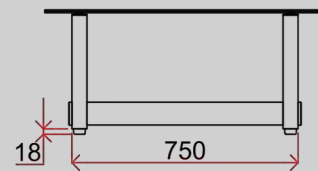

VISTA LATERAL

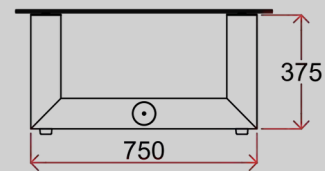

VISTA SUPERIOR

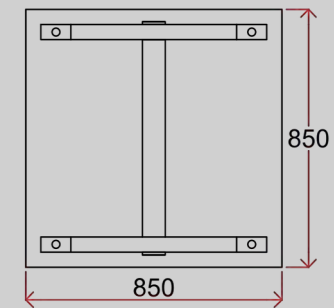

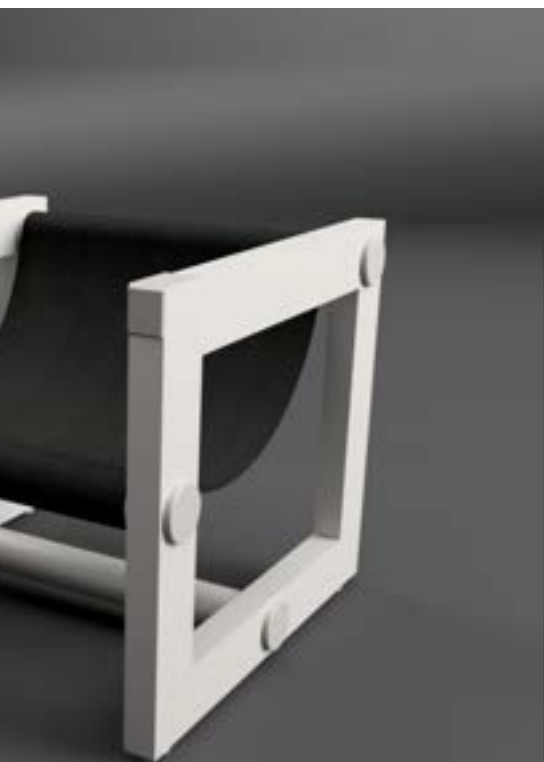
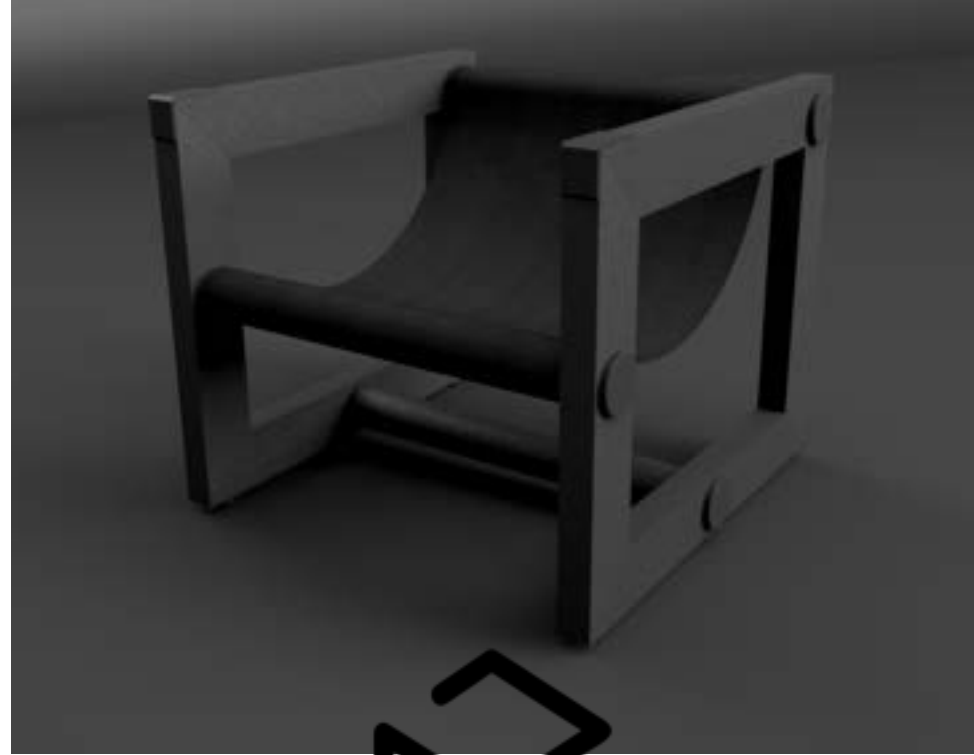



SBD

Sello
**Buen
Diseño**
argentino

SBD N° 6266
Línea Cúbica
Mobiliario de Aluminio
Aluplast SRL





LÍNEA CÚBICA





LÍNEA CÚBICA





LÍNEA CÚBICA



LÍNEA CÚBICA

ALUPLAST
ROBERTO



Armado en minutos



LÍNEA CÚBICA

Colección de **mobiliario en aluminio** diseñada para uso **interior y exterior**. Su estética moderna, basada en líneas simples se adapta con elegancia a cualquier entorno.

Estructura 100% aluminio: no se oxida, no se deforma y ofrece gran resistencia con un peso liviano.

Los tapizados, confeccionados con telas de alto desempeño, incorporan **protección UV y tratamiento antihongos** (Microban), garantizando durabilidad y confort en todo tipo de clima.

Disponible en **distintas combinaciones de color** —perfiles y telas—, cada pieza se ensambla fácilmente gracias a un sistema estructural galardonado con el **Sello de Buen Diseño**.

Ventajas: Mínima manutención, larga vida útil, diseño atemporal y la calidad que distingue a **Aluplast, con más de 50 años de experiencia**.



¿Quieres ver más?



www.aluplast.com.ar



[@aluplast.aberturas](https://www.instagram.com/aluplast.aberturas)



[@AluplastAberturas](https://www.facebook.com/AluplastAberturas)



+54 3446-635566



3446 48-0213



contacto@aluplast.com.ar